

Article number: 20958425

Description: E+G Levelling foot  
GN 343.3-25-M6-G

## Measures

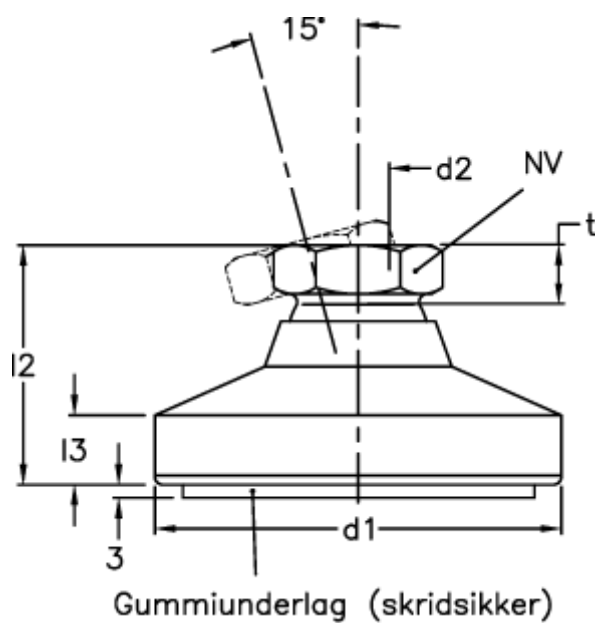

$d1$	= 25
$d2$	= M 6
$l2$	= 18.5
$l3$	= 4.0
$NV$	= 12.0
Static load (N)	= 5000
$t$ min	= 9.0